

# ● UNX-400 for Soldering ROBOT

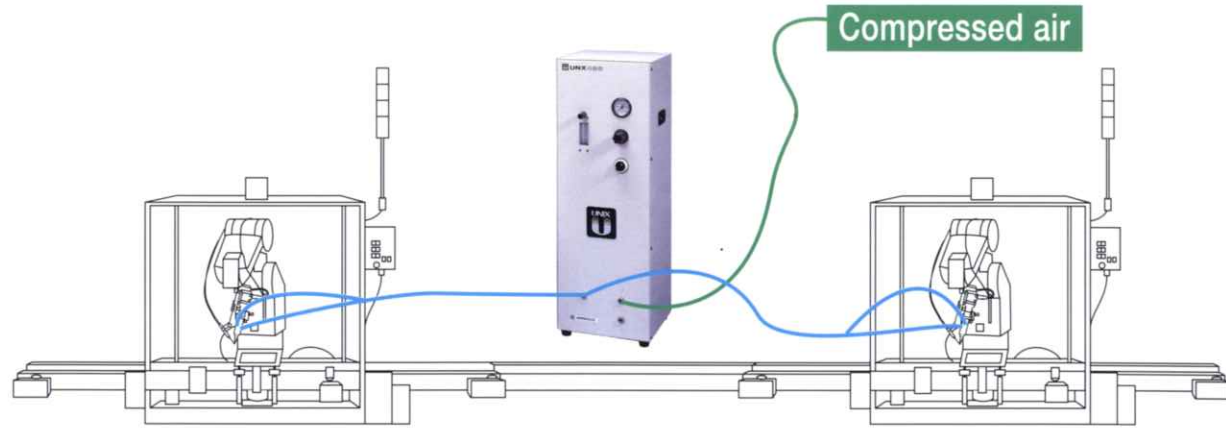

The concentration of generated nitrogen gas depends on the air pressure. (NL/min)

Product code	Supply air pressure (kg/cm <sup>2</sup> )	Nitrogen gas concentration in % and amount of generation in free liters per minute						
		99.9%	99.5%	99%	98%	97%	96%	95%
UNX-400	7.0	4.33	9.17	12.33	18.33	23.33	28.33	35.00
	6.0	3.50	7.50	10.00	14.67	18.33	23.33	28.33
	5.0	2.83	5.83	7.67	11.50	15.33	18.33	21.66
	4.0	2.00	4.16	6.00	8.50	10.66	13.38	16.66

※Use environment : 25°C

SPECIFICATIONS		
Product code	UNX-400	
Flow *	4L/min.	
Number of irons and robots connected to a nitrogen gas generator	Soldering iron	1 to 8
	Soldering robot	2
Air pressure	4 to 7kg/cm <sup>2</sup>	
Outline dimensions	250(W)×740(H)×250(D)mm	
Weight	Approx. 20kg	

\* Nitrogen gas generation capacity: The concentration of generated nitrogen gas depends on the air pressure.



Inquiry No.C00137  
Nitrogen Gas Generator Digest

# Nitrogen Gas Generator



UNX-100S  
UNX-100  
UNX-200  
UNX-400

- The specifications and exterior described in this catalog are subject to change without notice due to improvements.
- Safety note: Be absolutely sure to familiarize yourself with the Operating Instructions to ensure that this product will be used safely.

**JAPAN UNIX**

Head office :  
21-25, Akasaka 2-chome, Minato-ku, Tokyo 107-0052, Japan.  
☎ : +81-3-3588-0551 FAX : +81-3-3588-0554

Web site : <http://www.japanunix.co.jp/>

Contact:



# BEST SOLUTION FOR LEAD FREE SOLDERING

## Space-saving and low price

The nitrogen gas generator does not require a large space for installation as compared to gas cylinders or tanks. Ultra lightweight and small - sized equipment allows you to carry it around easily and smoothly. Moving it is simple and installation is feasible at a low cost. Reduction in running cost also possible.

## No need for power source

Connecting a compressed air (4-7kg/cm<sup>2</sup>) pipe is all that you need to do. No power supply is required.

## Simple and easy operation

The density and flow rate of nitrogen can be adjusted by simply using dial operations.

## Long and continuous operation is possible.

Since gas cylinders are not required, downtime arising from checking for residual gas in cylinders or for replacement of gas cylinders is eliminated. You can comfortably run the generator 24 hours a day.

## Maintenance-free

The flow meter does not require any maintenance because there are no electric units or driving units.

## Neither noise nor dust arises

Neither noise nor dust arises because the generator is not equipped with a driving section.

## \*Nitrogen (N<sup>2</sup>)

About 78% of the atmosphere is nitrogen and about 21%, or the remainder, is oxygen is active gas that promotes the respiration of living things. Nitrogen is an inactive gas that is difficult to combine with other substances.

## EXAMPLE OF LEAD-FREE SOLDER IN N<sup>2</sup> ATMOSPHERE (Pattern for QFPIC of 0.65mm pitch)

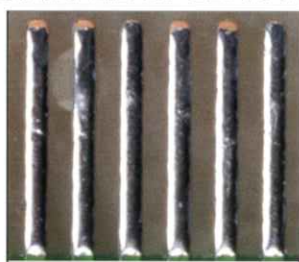

Eutectic Solder in Atmospheric Air (Sn,Pb/P-3)\*1

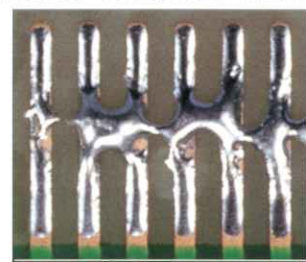

Lead-Free Solder in Atmospheric Air (Sn,Ag3.5,Cu0.75/P-3)

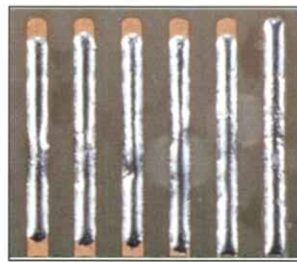

Lead-Free Solder in N2 Atmosphere (Sn,Ag3.5,Cu0.75/P-3)

\*1: Condition data shall be established as a standard that allows acceptable products when soldered using a soldering robot (LS-5TPS III).

## EFFECTS OF NITROGEN GAS SOLDERING

- Soldering without oxide film is possible.
- Bubbles (cavities) formed in the section of soldered parts are reduced.
- Faulty soldering such as cold joints, dry joints and insufficient wetting are reduced.
- Solder spreading ratio is increased.
- Soldering involves fewer solder bridges, floats and horns.
- Cycle time required for soldering is reduced.
- The height of fillets is stabilized.
- Insufficient gloss due to overheating is reduced.
- The number of solder balls and solder flux splashes is reduced.
- The life of iron tips is prolonged.
- The number of bad or cold joint lead wires is reduced.
- The amount of residual flux is remarkably reduced. (The amount of residual flux is usually 2-3%, but it is reduced even)

## GENERATOR FLOW SHEET

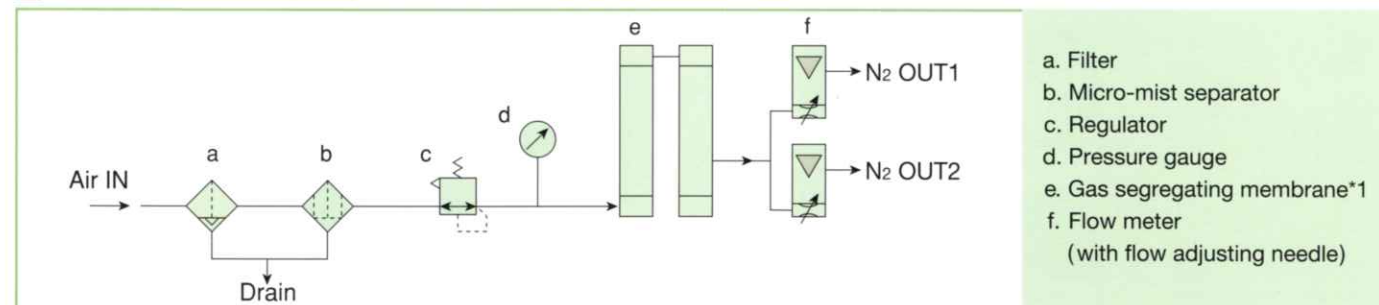

## PRINCIPLE OF SEGREGATION MEMBRANE SYSTEM

The speed of the particles contained in compressed air permeating through hollow segregation membranes varies. Nitrogen and air containing enriched oxygen are segregated using this principle.

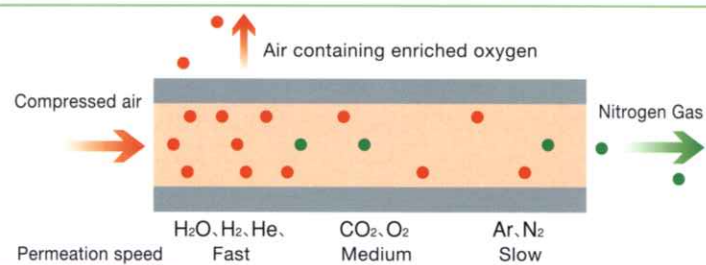

# SIMPLE & EASY WAY TO BUILD A NITROGEN ATMOSPHERE

## UNX-100S/UNX-100 for Soldering IRON

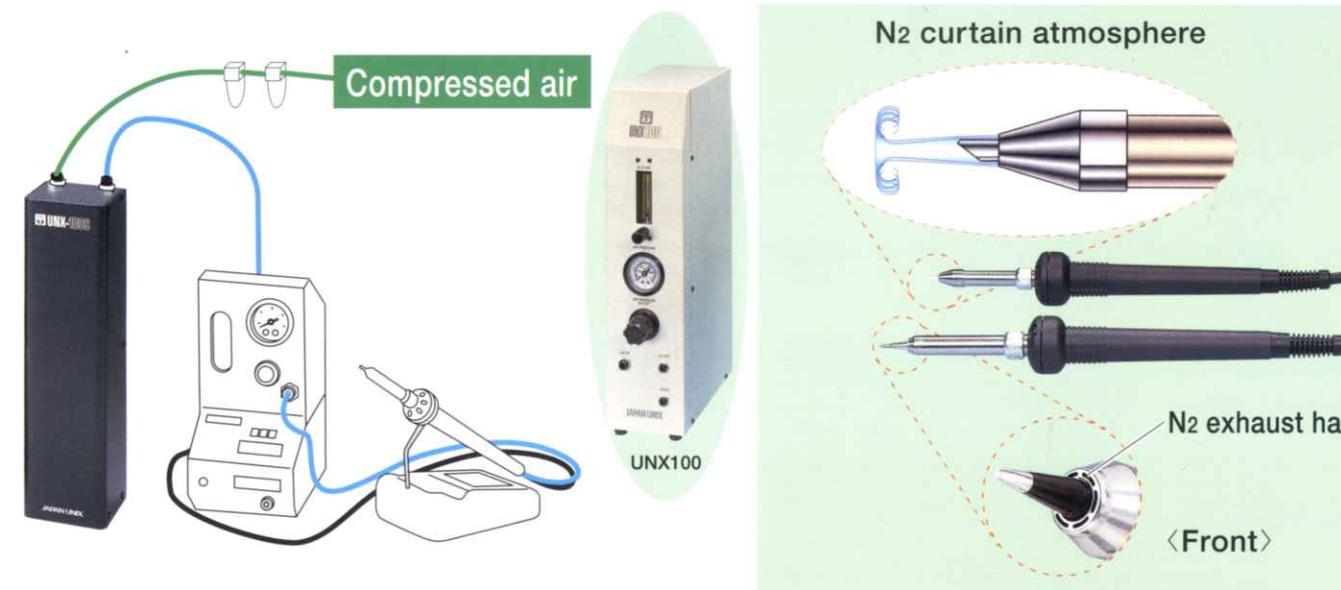

The concentration of generated nitrogen gas depends on the air pressure. (NL/min)

Product code	Supply air pressure (kg/cm <sup>2</sup> )	Nitrogen gas concentration in % and amount of generation in free liters per minute						
		99.9%	99.5%	99%	98%	97%	96%	95%
UNX-100S	7.0	0.42	0.88	1.18	1.67	2.33	2.83	3.17
	6.0	0.37	0.73	1.00	1.40	1.83	2.33	2.67
	5.0	0.27	0.57	0.80	1.13	1.45	1.67	2.17
	4.0	0.18	0.43	0.58	0.82	1.07	1.28	1.52
UNX-100	7.0	1.00	1.83	2.50	3.50	4.50	5.50	6.67
	6.0	0.80	1.50	2.00	2.83	3.67	4.33	5.33
	5.0	0.62	1.10	1.60	2.17	2.83	3.50	4.17
	4.0	0.43	0.78	1.15	1.58	2.00	2.50	3.00

\*Use environment: 25°C

SPECIFICATIONS		
Product code	UNX-100S	UNX-100
Flow*	0.5L/min.	1L/min.
Number of irons and robots connected to a nitrogen gas generator	Soldering iron	1 to 2
	Soldering robot	1 to 3
Air pressure	4 to 7kg/cm <sup>2</sup>	4 to 7kg/cm <sup>2</sup>
Outline dimensions	80(W)×83.5(H)×300(D)	100(W)×430(H)×240(D)
Weight	Approx. 1.9kg	Approx. 6.5kg

\*Nitrogen gas generation capacity: The concentration of generated nitrogen gas depends on the air pressure.

## UNX-200 for Soldering ROBOT

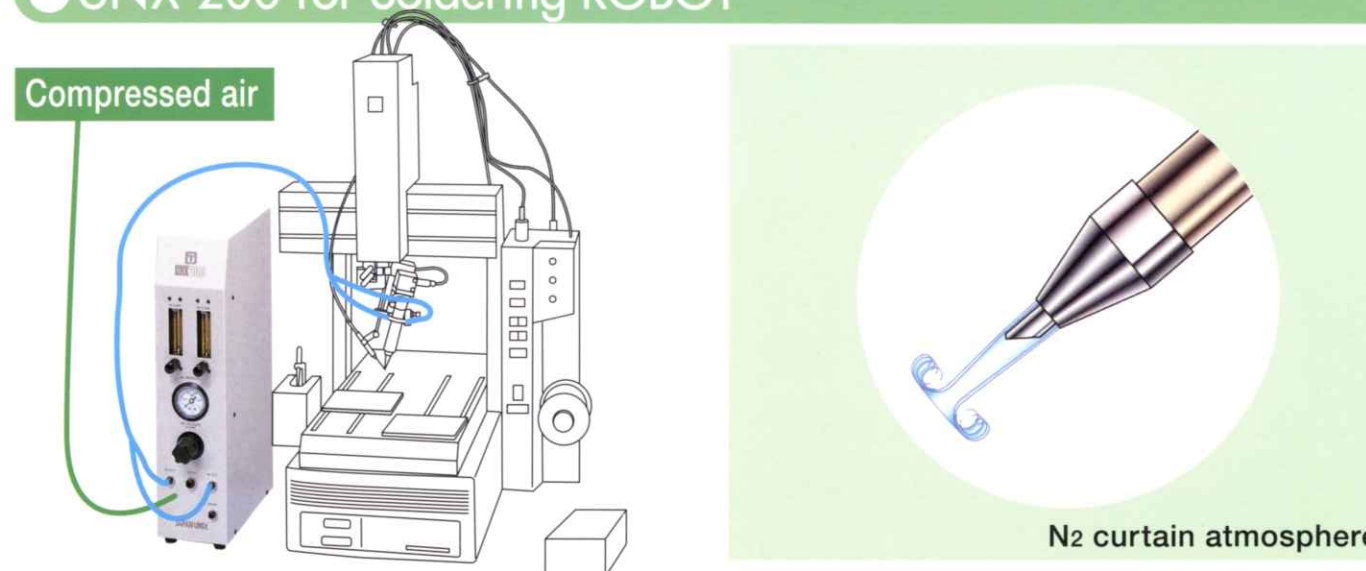

The concentration of generated nitrogen gas depends on the air pressure. (NL/min)

Product code	Supply air pressure (kg/cm <sup>2</sup> )	Nitrogen gas concentration in % and amount of generation in free liters per minute						
		99.9%	99.5%	99%	98%	97%	96%	95%
UNX-200	7.0	2.0	3.66	5.0	7.0	9.0	11.0	13.34
	6.0	1.6	3.0	4.0	5.66	7.34	8.66	10.66
	5.0	1.23	2.2	3.2	4.33	5.66	7.0	8.34
	4.0	0.86	1.57	2.3	3.16	4.0	5.0	6.0

\*Use environment: 25°C

SPECIFICATIONS		
Product code	UNX-200	
Flow*	2L/min.	
Number of irons and robots connected to a nitrogen gas generator	Soldering iron	1 to 4
	Soldering robot	1
Air pressure	4 to 7kg/cm <sup>2</sup>	
Outline dimensions	100(W)×430(H)×240(D)mm	
Weight	Approx. 8kg	

\*Nitrogen gas generation capacity: The concentration of generated nitrogen gas depends on the air pressure.